

Modular Manifold Systems

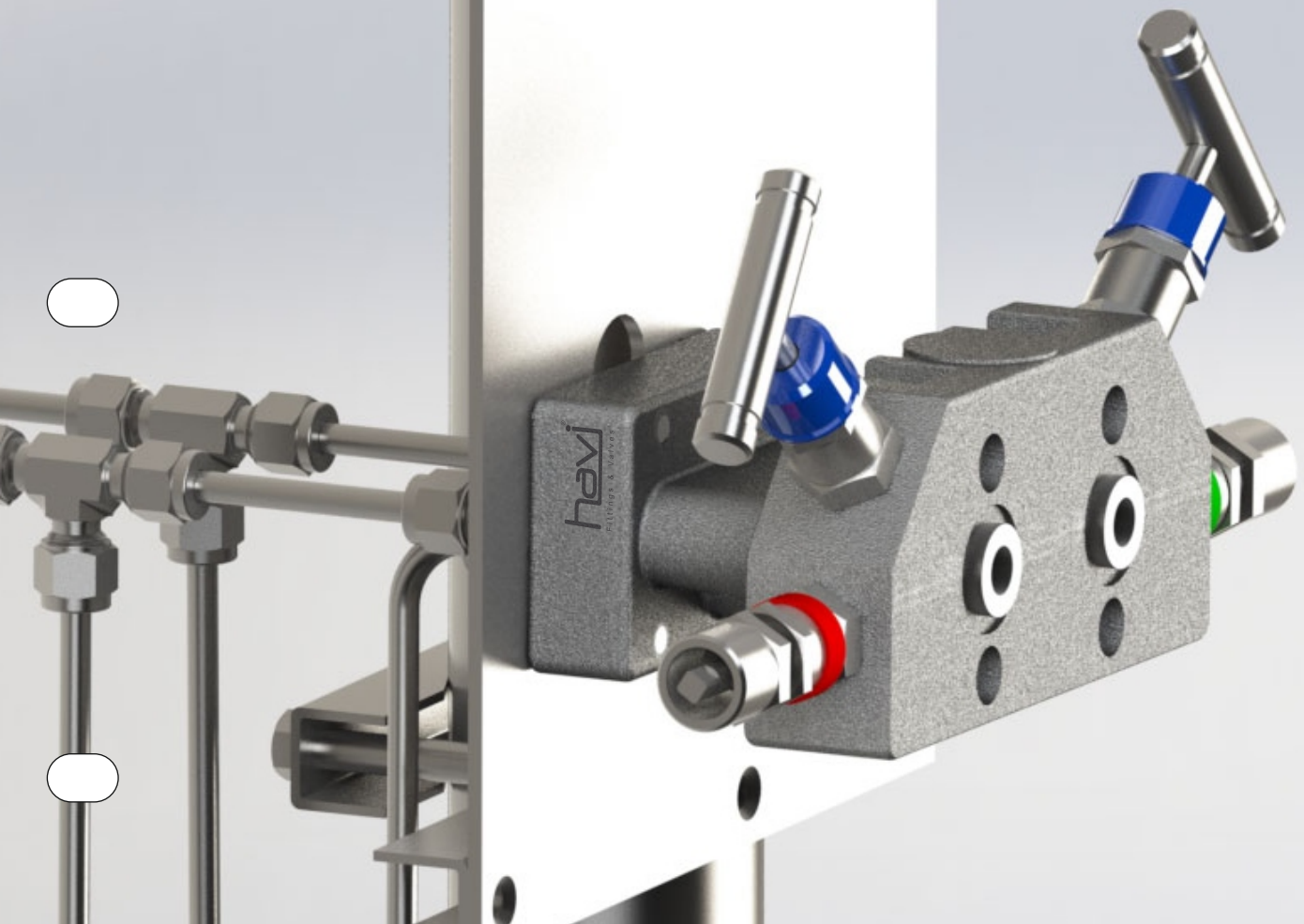

HAVI Modular Mounting Manifolds are specifically designed with butterfly mounting arrangement which is compatible with the Shell specification for Process Instrumentation.

·A standard series of 2 Valve & 4 Valve manifolds for pressure measurement. The Instrument Manifolds provide Isolate & Drain function for local instrument or indicator mounting. ·Hydrostatic Test certificate along with complete chemical & physical material certificates.

The main distinction of MMV series is that it eliminates the need for extra mounting accessories & reduces pipe work on site as these specially designed Manifolds can be easily assembled to a standard mounting plate

- ·All valves are appropriately color coded & labeled.
- ·Standard PTFE stem packing.
- ·Process & Drain end connection with locking arrangement.
- ·Standard material grade manufactured is SS316.
- ·Instrument mounting face in accordance with DIN 19213.
- ·Cast Manifold body CF8M/ASTM A351

Bonnet Assembly Features

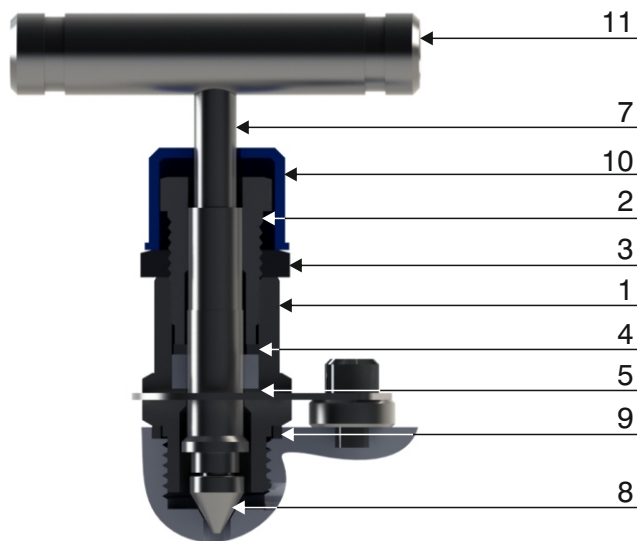

SI	Description	Material
1	Bonnet	SS 316
2	Pusher	SS 316
3	Check Nut	SS 316
4	Packing	SS 316
5	Packing	PTFE
6	Locking Arrangement	SS 304
7	Spindle	SS 316
8	Tip	SS 316
9	Packing	SS 316
10	Dust Cap	LDPE
11	Handle	SS 304

- Metal to Metal Seating arrangement
- Seals as a standard in PTFE and Grphoil as option
- Thread rolled and Burnished Sealing area
- Silver plated Pusher for Anti Galling
- Easily removable Bonnet Locking arrangement
- Differential hardened Tip for better life
- Non-rotating Tip design
- Blow out proof design of Spindle
- Color coding for Bonnet application
- Anti tamper arrangement Drain and Equalise Bonnets

Four Valve Modular Manifold System

Model : 4MMVA

2 Isolation, 1 Drain, 1 Equalise

Directly mounted on transmitter at a center distance of 54.00 mm

Supplied along with Mounting Bolts, Seals and Nut

Anti Tamper Drain and Equalise Bonnets

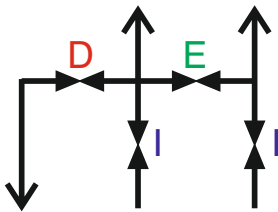

I - Isolate
E - Equalise
D - Drain

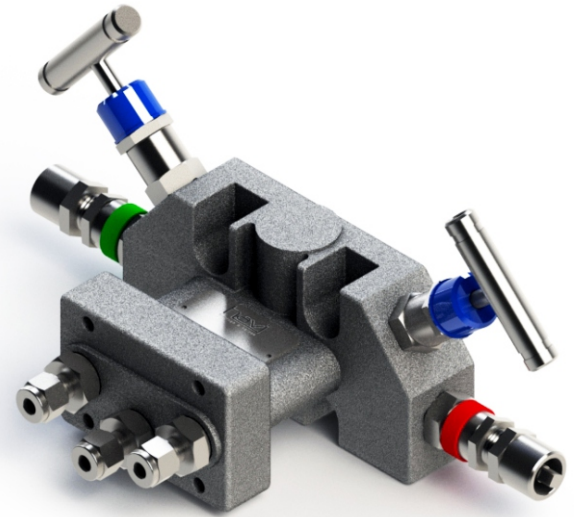

Four Valve Modular Manifold System

Model : 4MMVB

2 Isolation, 2 Drain

Directly mounted on transmitter at a center distance of 54.00 mm

Supplied along with Mounting Bolts, Seals and Nut

Anti Tamper Drain Bonnets

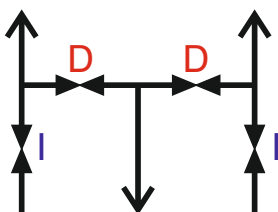

I - Isolate
D - Drain

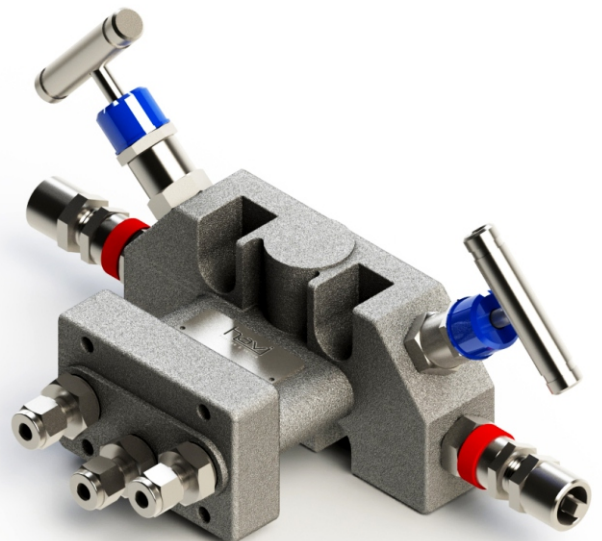

Two Valve Modular Manifold System

Model : 2MMVA

1 Isolation, 1 Drain

Directly mounted on transmitter at a center distance of 54.00 mm

Supplied along with Mounting Bolts, Seals and Nut

Anti Tamper Drain Bonnets

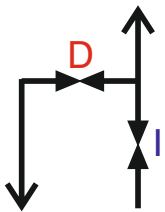

I - Isolate

D - Drain

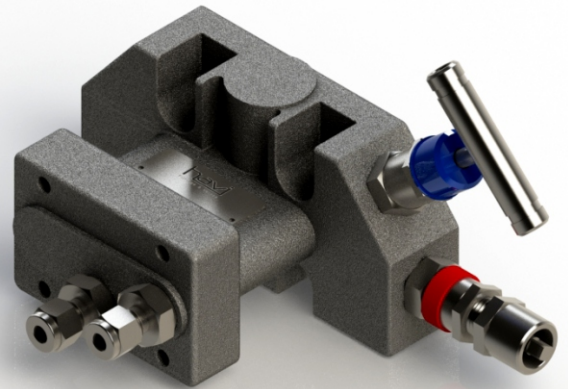

Two Valve Modular Manifold System

Model : 2MMVB

1 Isolation, 1 Drain

Directly mounted on transmitter at a center distance of 54.00 mm

Supplied along with Mounting Bolts, Seals and Nut

Anti Tamper Drain Bonnets

Used for Low Pressure applications

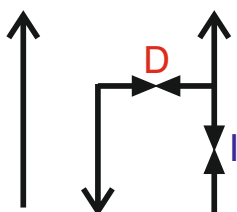

I - Isolate

D - Drain

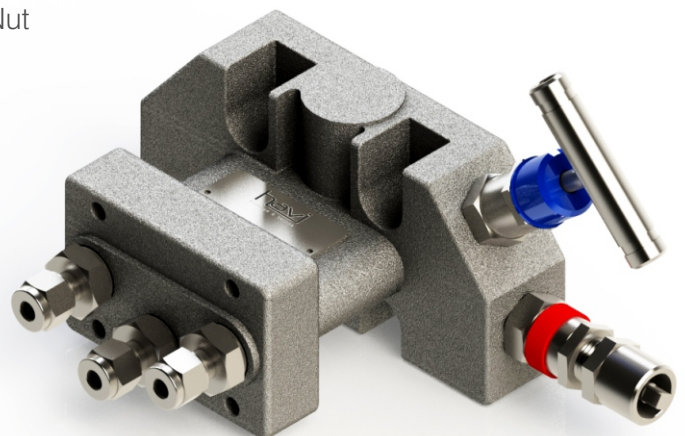

Two Valve Modular Manifold System

Model : 2MMVC

1 Isolation, 1 Drain

Directly connected to transmitter or Pressure gauges

Supplied along with Mounting Bolts, Seals and Nut

Anti Tamper Drain Bonnets

Gauge Adaptor integral with the Manifold

for 360 deg positioning

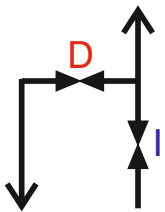

I - Isolate

D - Drain

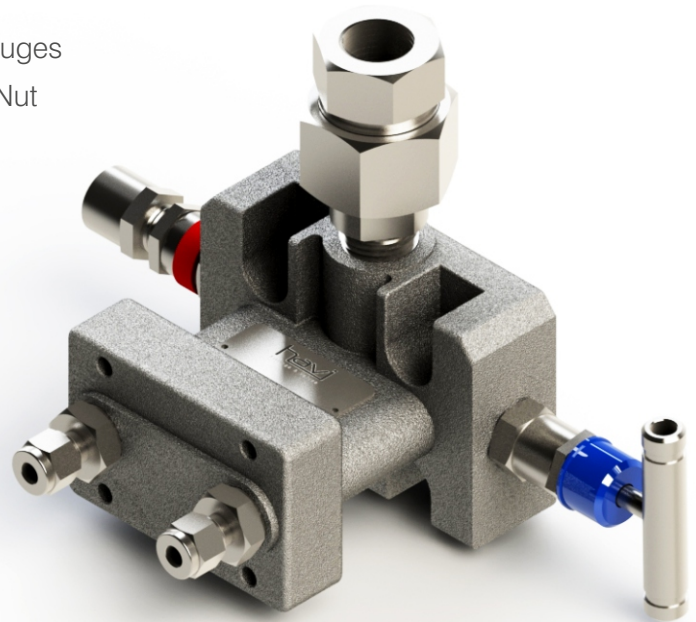

Ordering Information

2MMVA	6MT	P	S6	N
Model Number	Inlet & Drain Connection	Material of Packing	Material of Construction	Additional Information
<p>Male Connector size</p> <p>6MT - 6mm x 1/4" BSPP 4T - 1/4" x 1/4" BSPP 10MT - 10mm x 1/4" BSPP 6T - 3/8" x 1/4" BSPP</p> <p>P - PTFE G - Graphoil</p> <p>S6 - Stainless Steel 316 S6L - Stainless Steel 316L B - Brass C - Carbon Steel M - Alloy 400 H - Alloy C276 T - Titanium</p> <p>LH - Locking Handle N - NACE</p>				

Filling Connector

Ordering Information :

FC-6MT (6mm Tube Fitting) / FC-4T (1/4" Tube Fitting)

Soft Seated Non Return Valve integral with Body

Directly Mounted on Transmitter face with 54mm center distance

Retaining cap fixed with chain

Supplied with Bolts, Seals and Nuts

Working pressure of 6000 psi



Blind Flange

Ordering Information :

BF

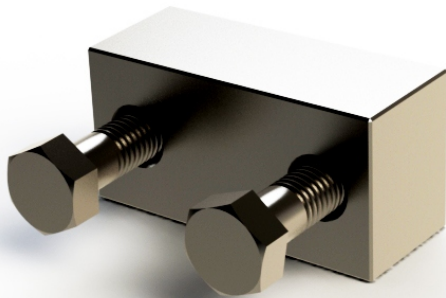

Anti Tamper Bonnet Key

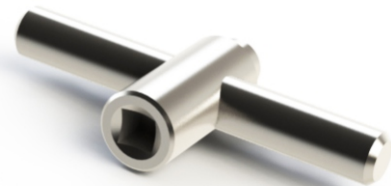

Mounting Plate

Ordering Information :

MPA

For mounting of Manifold, protection shade

Suitable for mounting on 2" Pipe Stand

All Fasteners, Brackets and Clamps are included

MOC : SS316

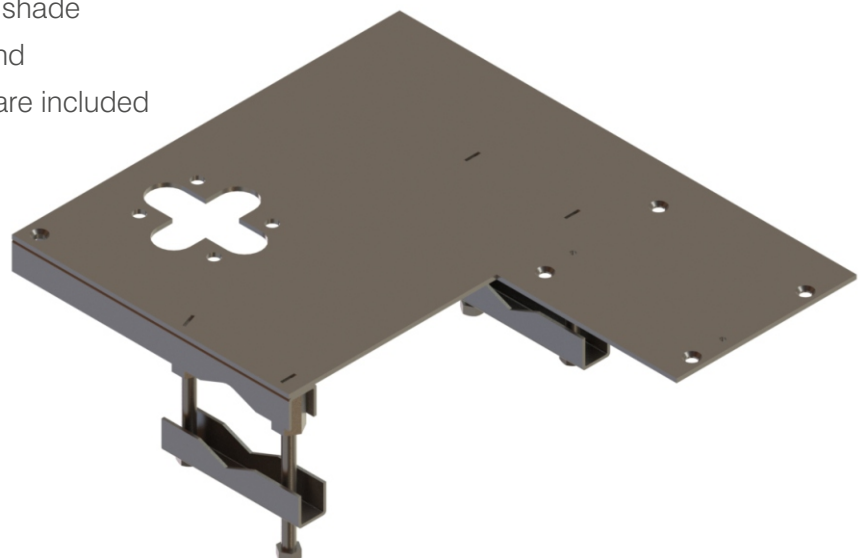

vipal enterprises pvt ltd

32, 34 Blue Chip Industrial Estate No.5,
Sativali Road, Vasai East, Thane 401208,
Maharashtra, India.

Email: sales@havi.in

Website: www.havi.in

Компания ВСП

107023, Россия, Москва,
Семеновская площадь, 1а, 18 этаж

+7 499 4040080

vsp@vsp-co.org

www.vsp-co.org

